

**VELUX®**

---

# VELUX ELECTRIC DML/RML



VAS 455013-2023-10

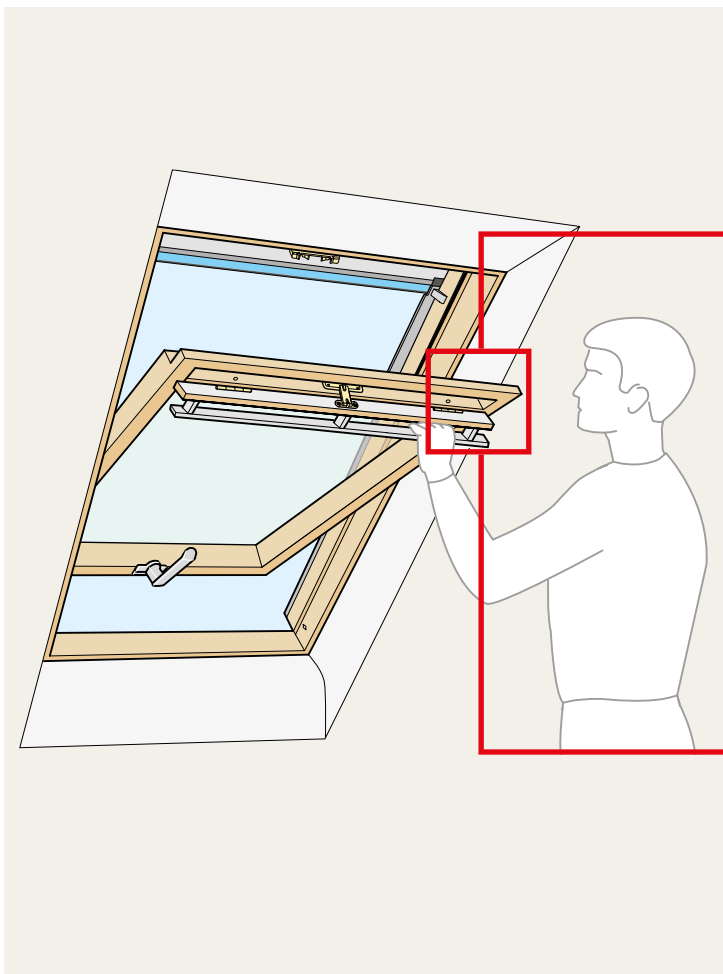

# INTEGRA®



PAGES  
4-17



PAGES  
18-35

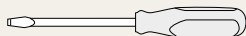
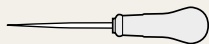
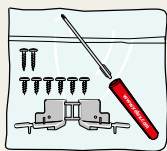
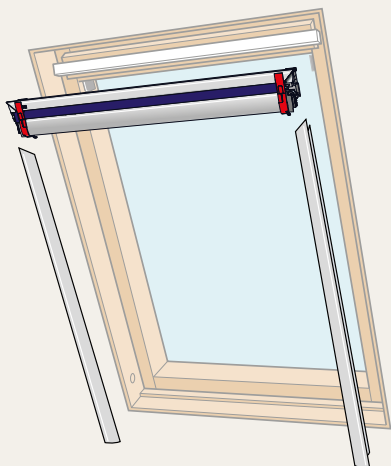

1

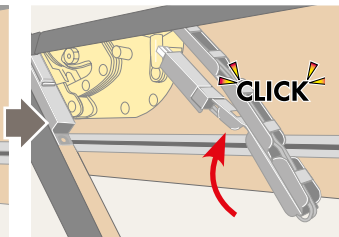
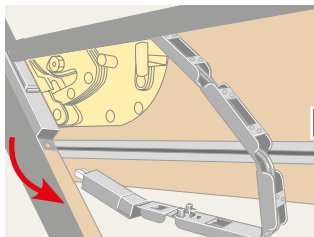
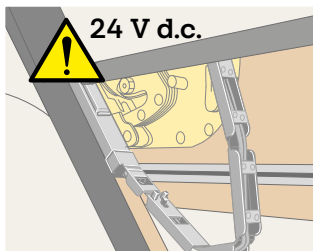
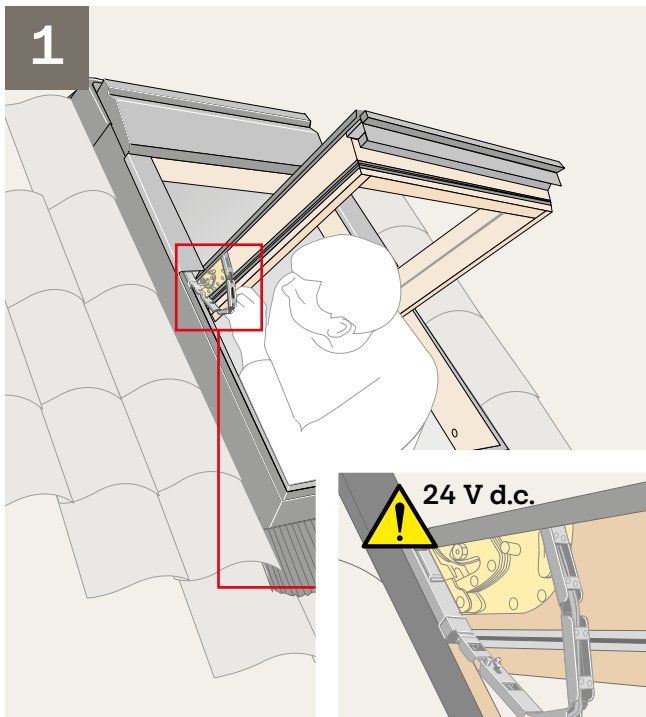

2

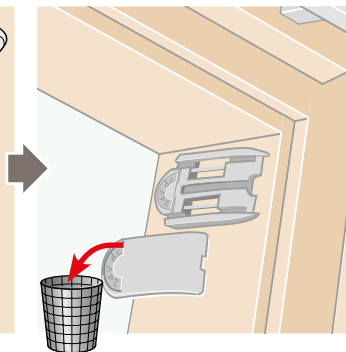
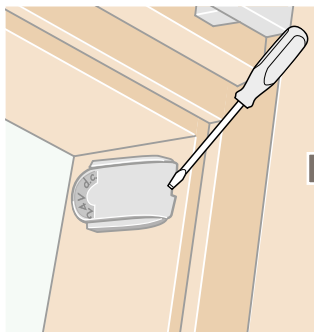
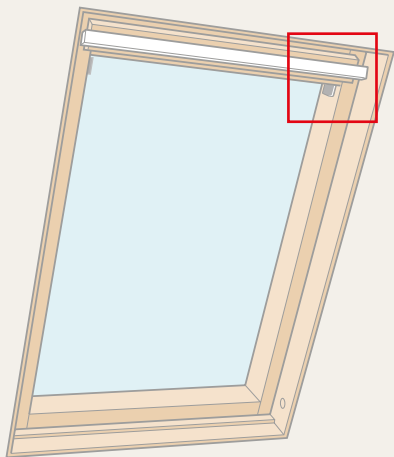

3

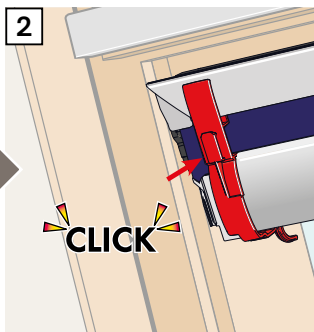
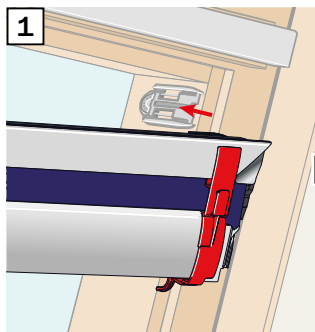
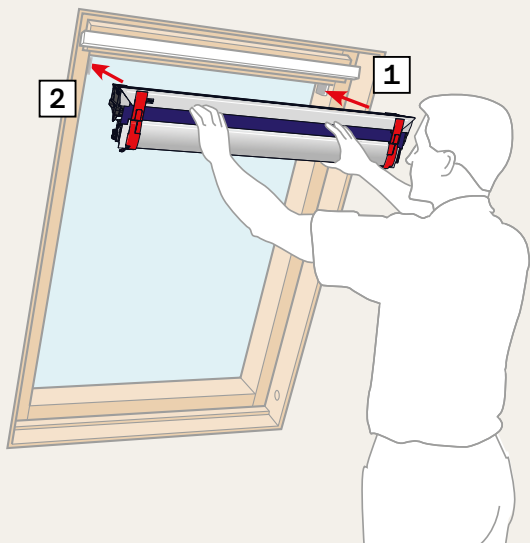

4

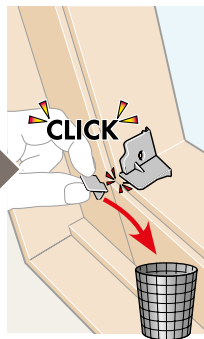
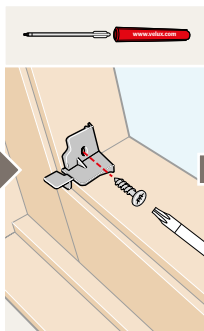
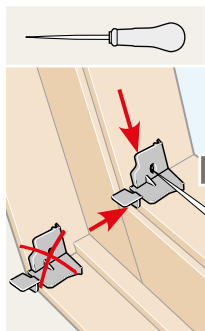
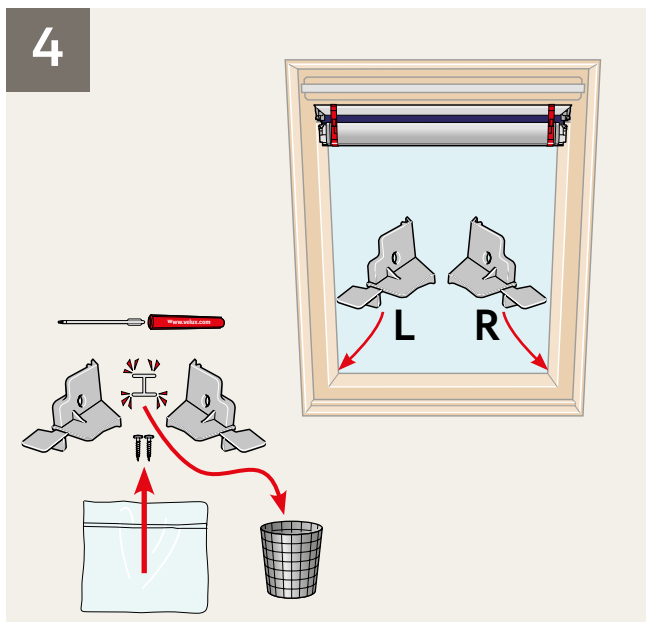



5

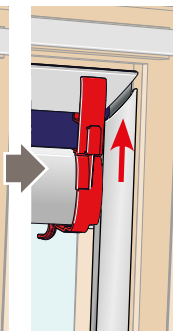
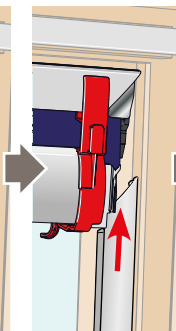
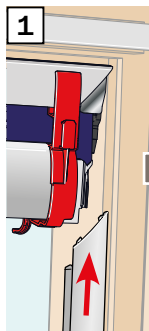
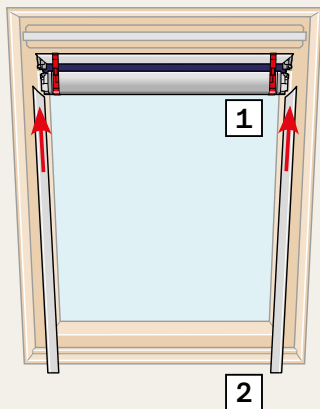
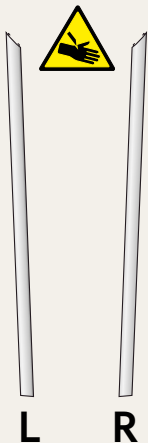

6

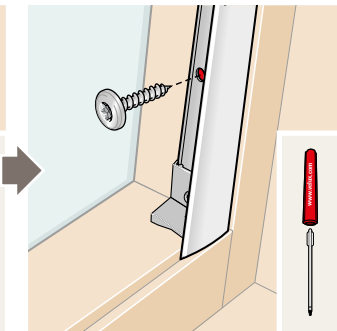
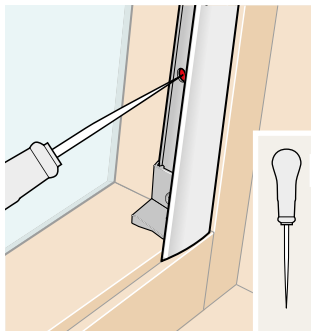
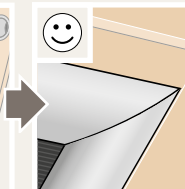
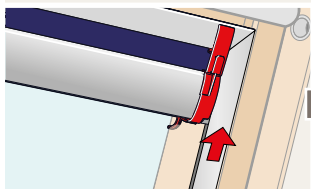
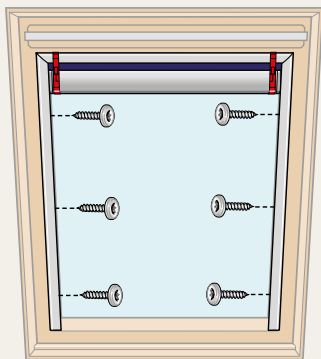
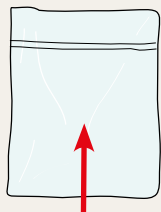

7

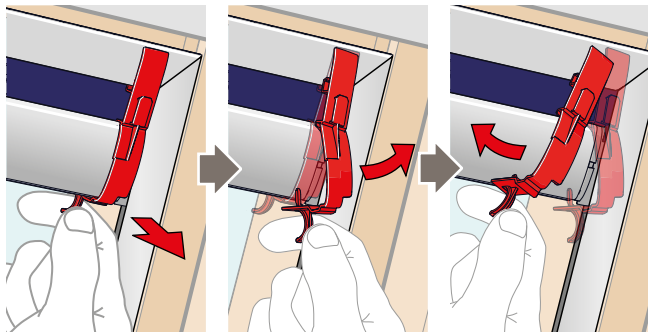
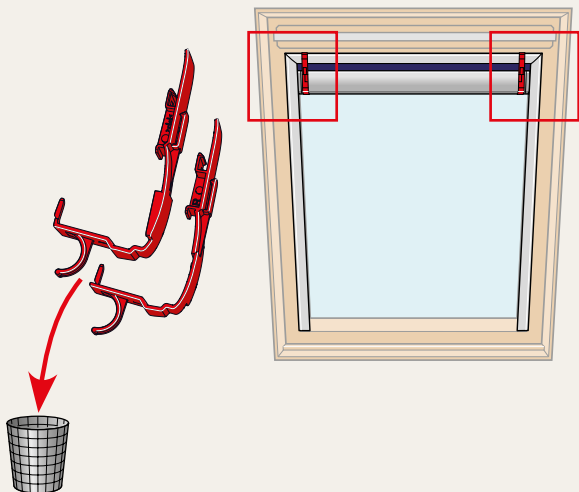

8

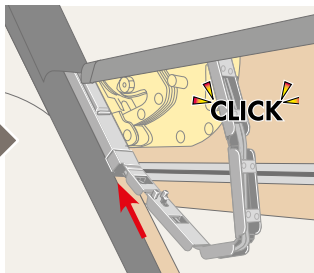
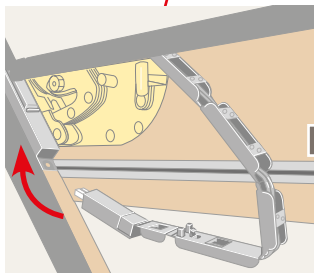
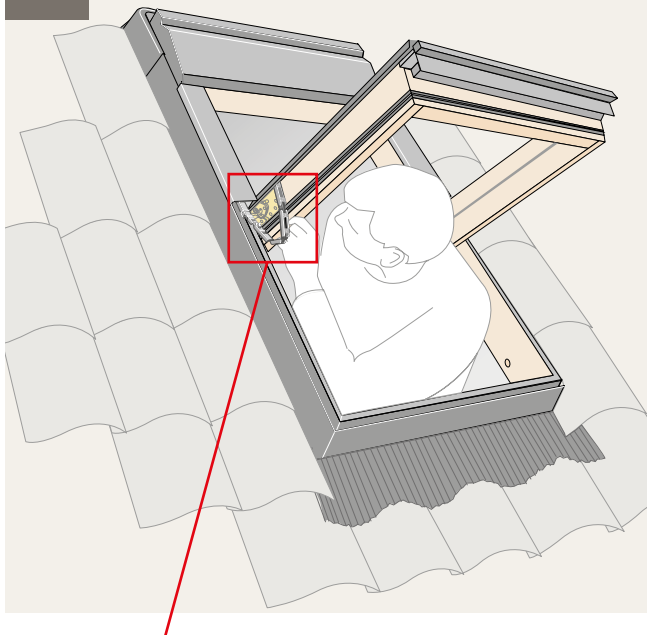

9

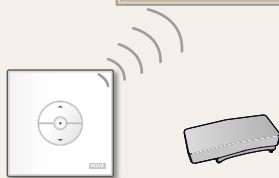
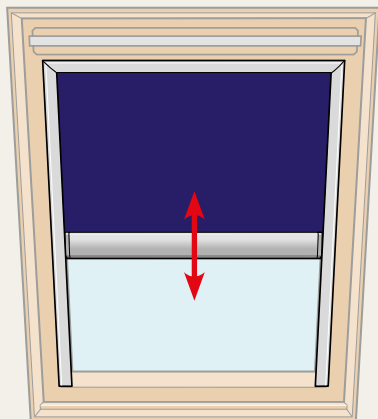

[www.velux.com/electricalsupport](http://www.velux.com/electricalsupport)

10

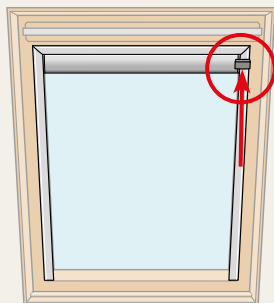
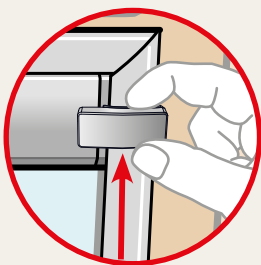
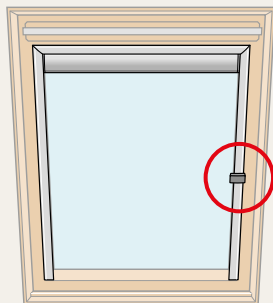
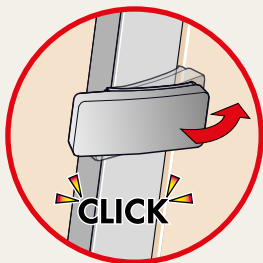
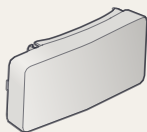

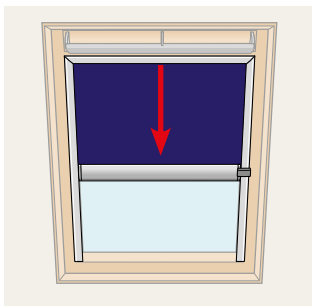
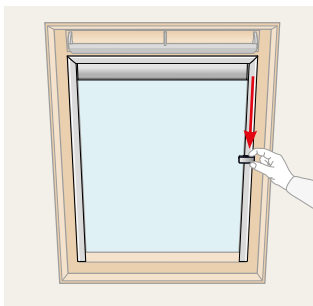
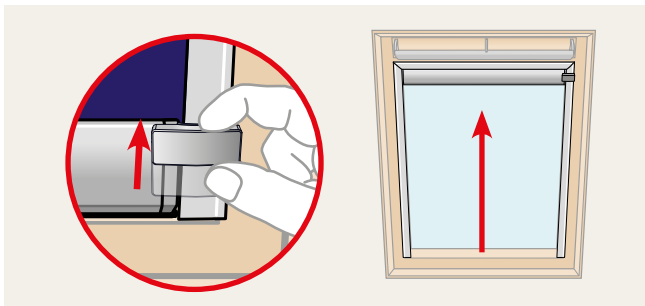
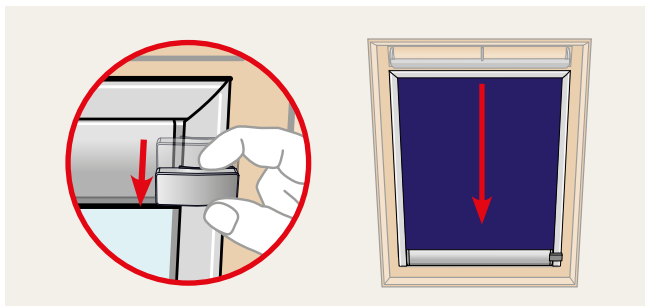

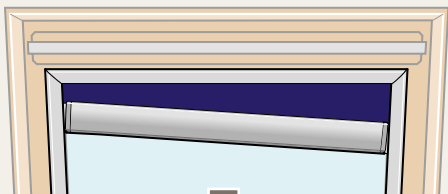
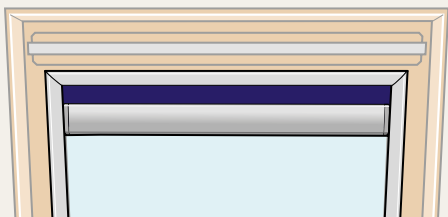





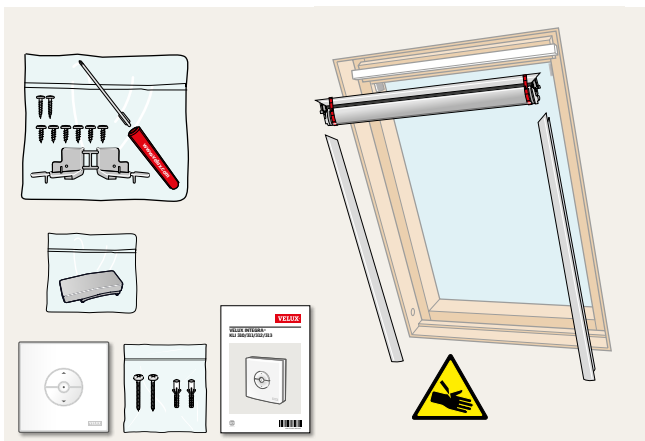

## ZOZ 243

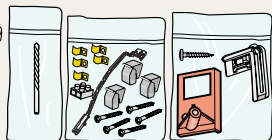

## ZOZ 244

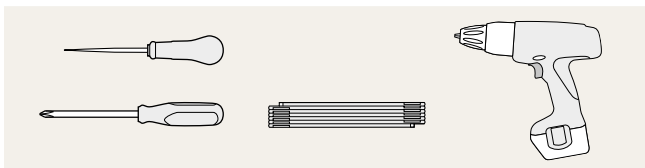
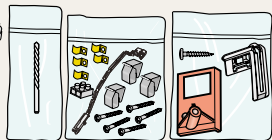

1

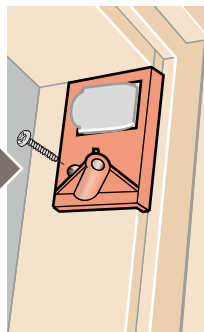
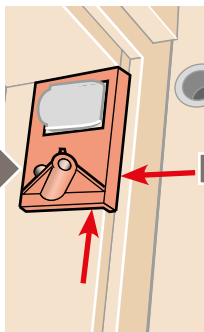
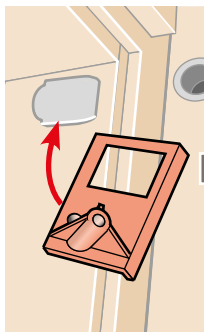
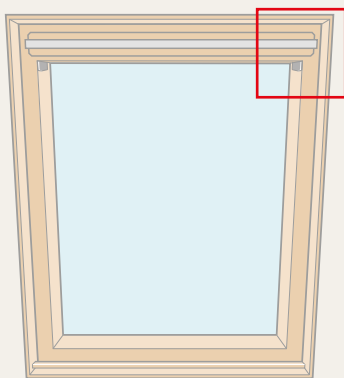
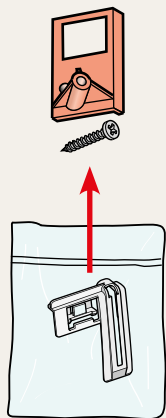

2

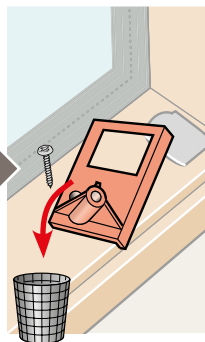
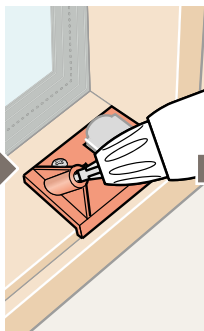
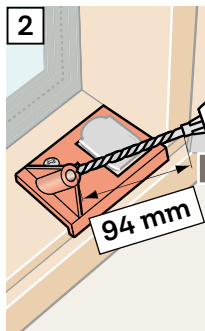
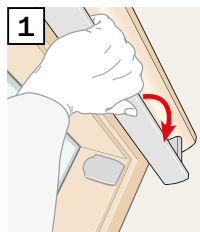
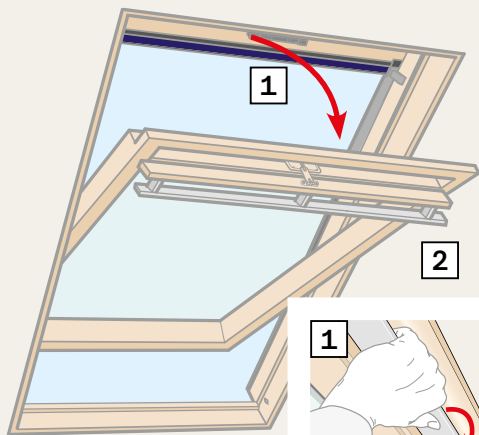
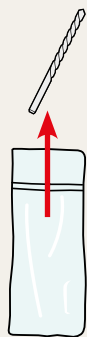

3

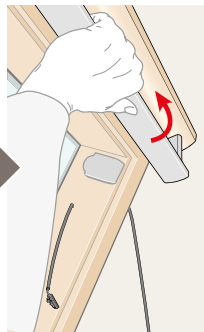
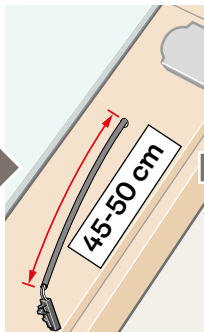
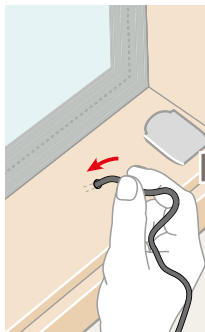
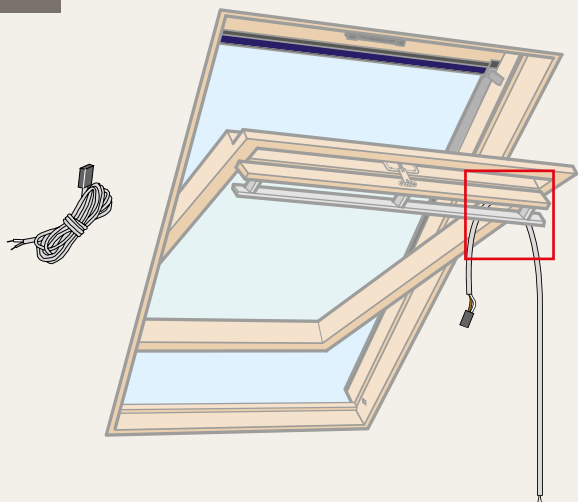

4

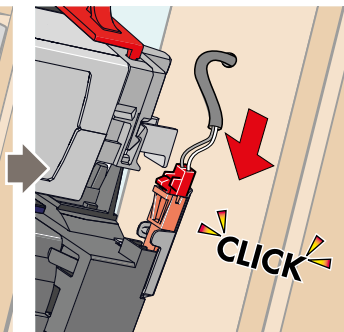
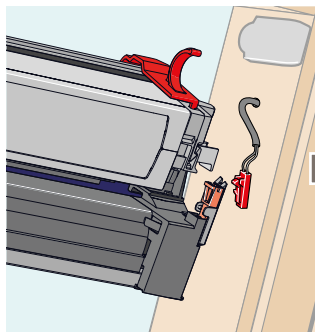
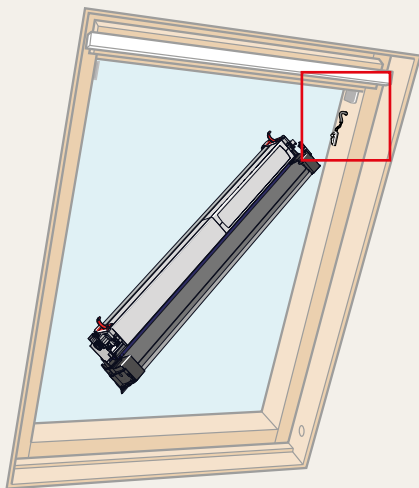

5

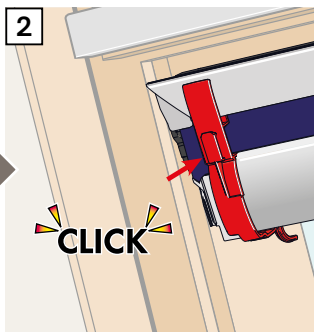
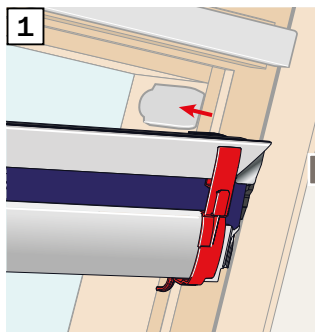
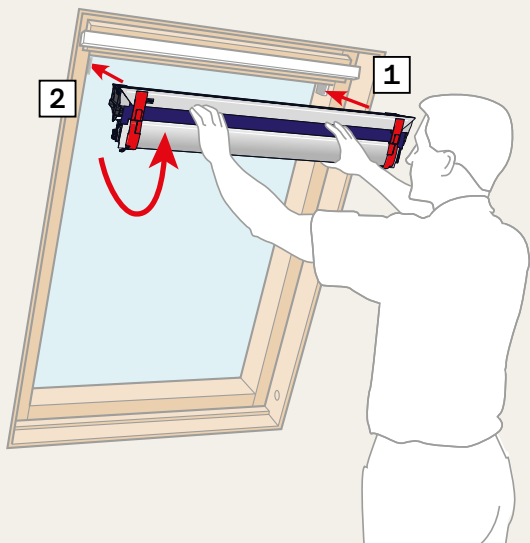

6

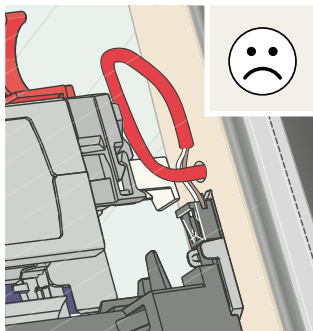
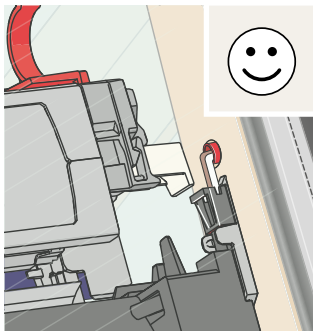
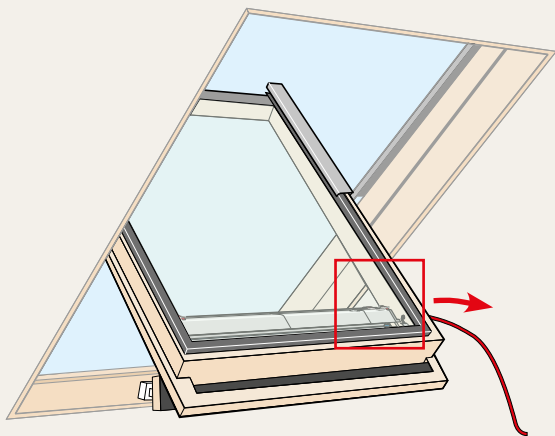



7

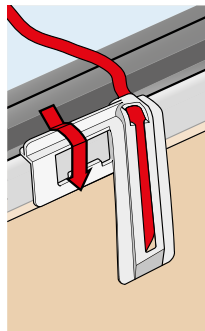
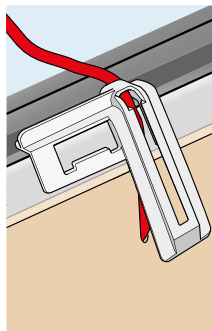
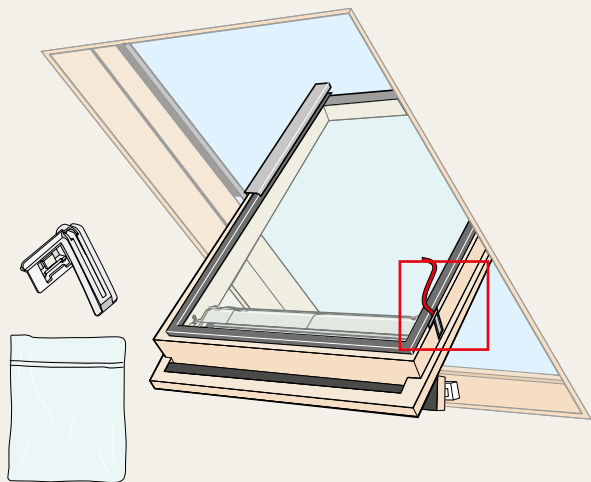

8

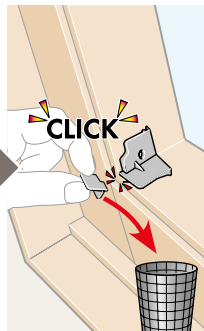
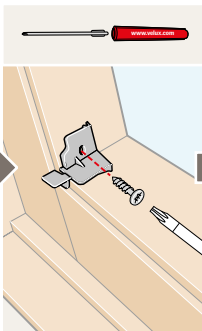
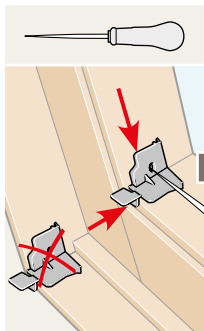
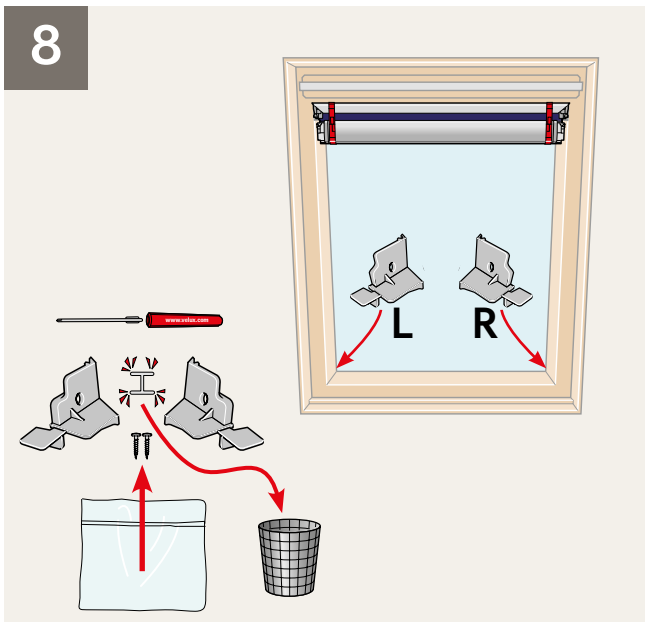

9

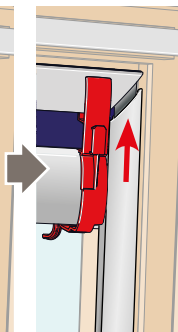
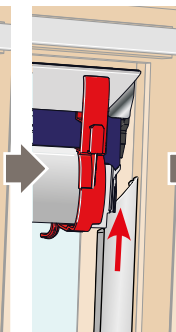
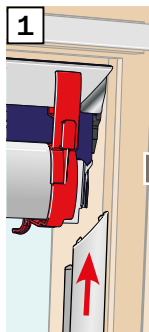
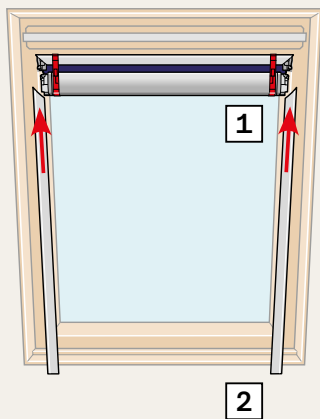
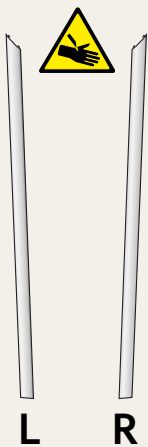

10

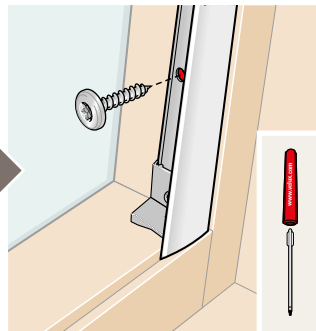
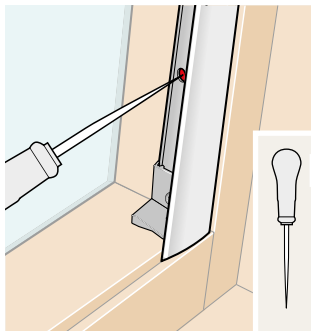
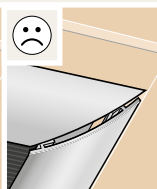
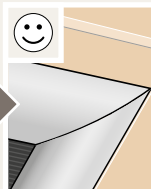
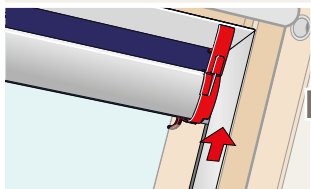
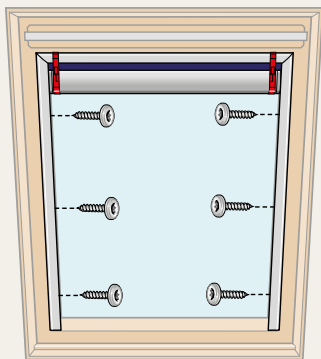
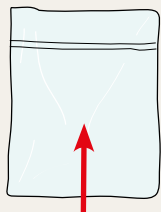

# 11

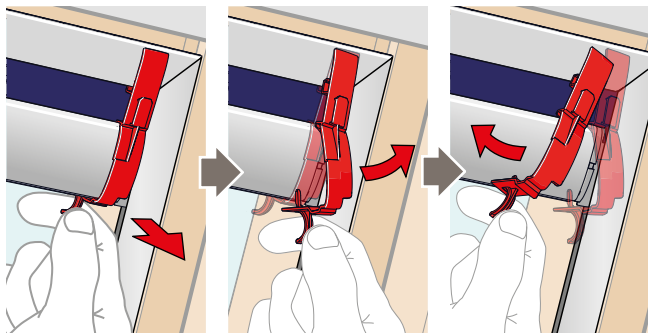
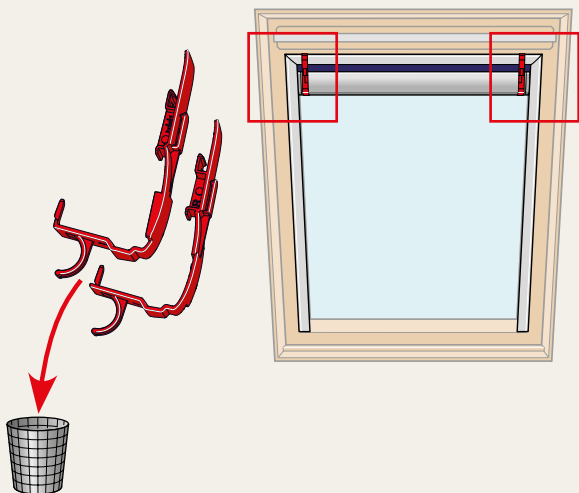

# 12

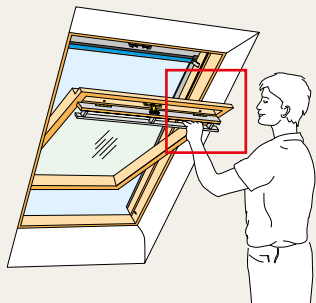

B04  
C01·C02·C04·C06  
F04·F06·F08  
M04·M06·M08·M10·M12  
P25·P04·P06·P08·P10  
S01·S06·S08·S10  
U04·U08·U10  
X99



064  
101·102·104  
204·206  
325·304·306  
308·310·312  
425·404·406·408·410  
601·606·608·610  
804·808·810  
1·2·3·4·5·6·7·8·9  
10·11·13·14·31·999



13

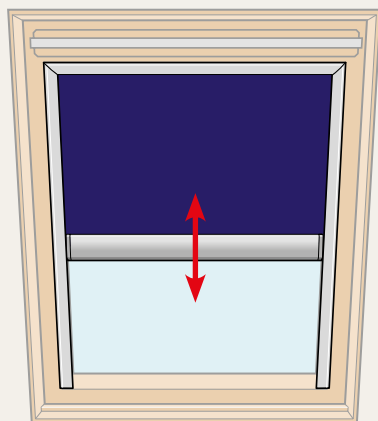

[www.velux.com/electricalsupport](http://www.velux.com/electricalsupport)

14

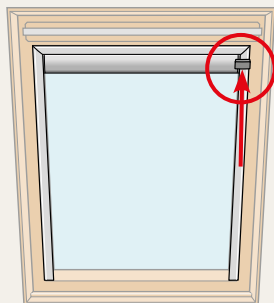
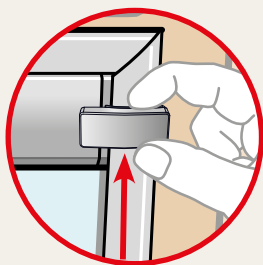
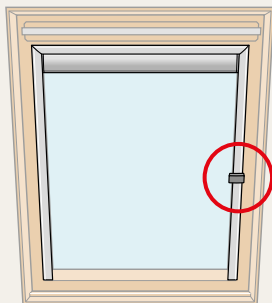
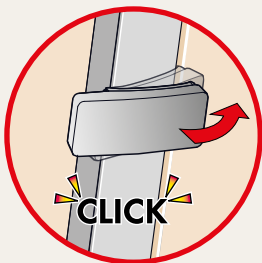
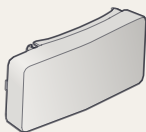



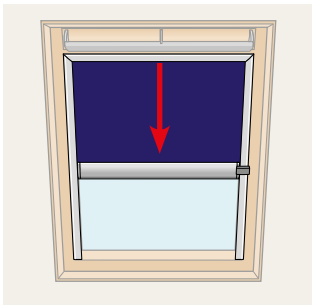
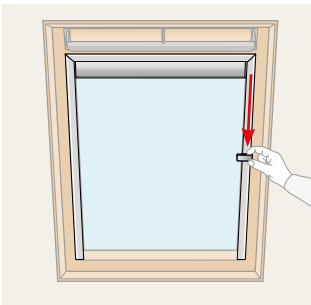
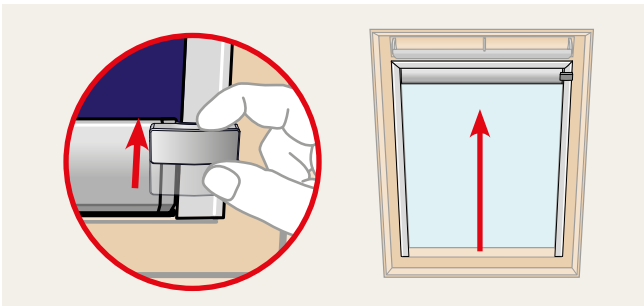
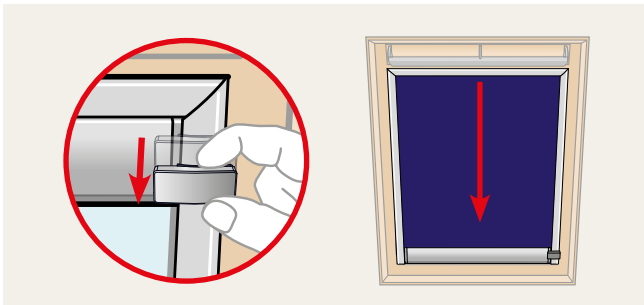

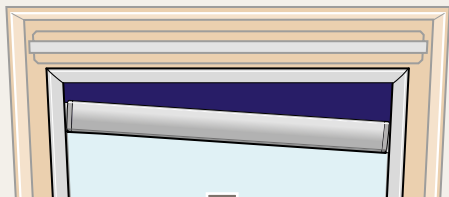
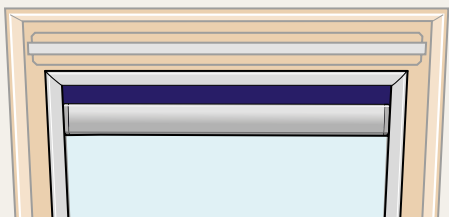

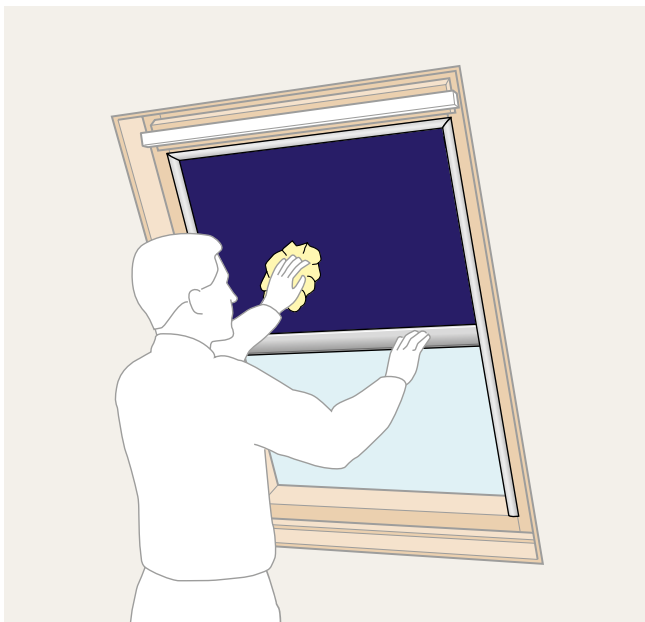

**VELUX®**

<b>AR:</b> VELUX Export (VELUX A/S) + 45 4516 7885	<b>IT:</b> VELUX Italia s.p.a. 045/6173666
<b>AT:</b> VELUX Österreich GmbH 02245/32 3 50	<b>JP:</b> VELUX-Japan Ltd. 0570-00-8141
<b>AU:</b> VELUX Australia Pty. Ltd. 1300 859 856	<b>KR:</b> VELUX Export (VELUX A/S) + 45 4516 7885
<b>BA:</b> VELUX Bosna i Hercegovina d.o.o. 033/626 493, 626 494	<b>LT:</b> VELUX Lietuva, UAB (85) 270 91 01
<b>BE:</b> VELUX Belgium (010) 42.09.09	<b>LV:</b> VELUX Latvia SIA 67 27 77 33
<b>BG:</b> ВЕЛУКС България ЕООД 02/955 99 30	<b>NL:</b> VELUX Nederland B.V. 030 - 6 629 629
<b>CA:</b> VELUX Canada Inc. 1 800 88-VELUX (888-3589)	<b>NO:</b> VELUX Norge AS 22 51 06 00
<b>CH:</b> VELUX Schweiz AG 062 289 44 45	<b>NZ:</b> VELUX New Zealand Ltd. 0800 650 445
<b>CL:</b> VELUX Export (VELUX A/S) + 45 4516 7885	<b>PL:</b> VELUX Polska Sp. z o.o. (022) 33 77 000 / 33 77 070
<b>CN:</b> VELUX (CHINA) CO. LTD. 0316-607 27 27	<b>PT:</b> VELUX Portugal, Lda 21 880 00 60
<b>CZ:</b> VELUX Česká republika, s.r.o. 531 015 511	<b>RO:</b> VELUX România S.R.L. 0268-402740
<b>DE:</b> VELUX Deutschland GmbH www.velux.de/kontakt	<b>RS:</b> VELUX Srbija d.o.o. 011 20 57 500
<b>DK:</b> VELUX Danmark A/S 45 16 45 16	<b>SE:</b> VELUX Svenska AB 042/20 83 80
<b>EE:</b> VELUX Eesti OÜ 621 7790	<b>SI:</b> VELUX Slovenija d.o.o. 01 724 68 68
<b>ES:</b> VELUX Spain, S.A.U. 91 509 71 00	<b>SK:</b> VELUX Slovensko, s.r.o. (02) 33 000 555
<b>FI:</b> VELUX Suomi Oy 0207 290 800	<b>TR:</b> VELUX Çatı Pencereleri Ticaret Limited Şirketi 0 216 302 54 10
<b>FR:</b> VELUX France 0806 80 15 15 Service gratuit + prix appel	<b>UA:</b> ТОВ "ВЕЛЮКС Україна" (044) 2916070
<b>GB:</b> VELUX Company Ltd. 01592 778 225	<b>US:</b> VELUX America LLC 1-800-88-VELUX
<b>HR:</b> VELUX Hrvatska d.o.o. 01/5555 444	
<b>HU:</b> VELUX Magyarország Kft. (06/1) 436-0601	
<b>IE:</b> VELUX Company Ltd. 01 848 8775	

[www.velux.com](http://www.velux.com)